

# LEDLENSER ML4

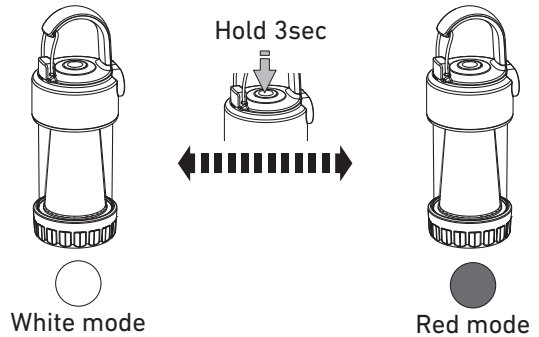

## White Mode

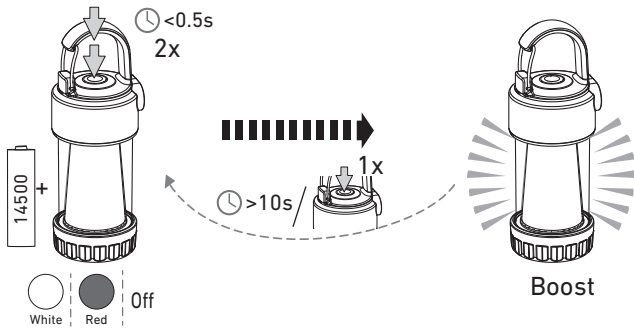
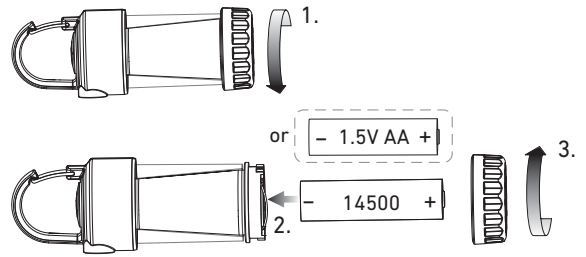
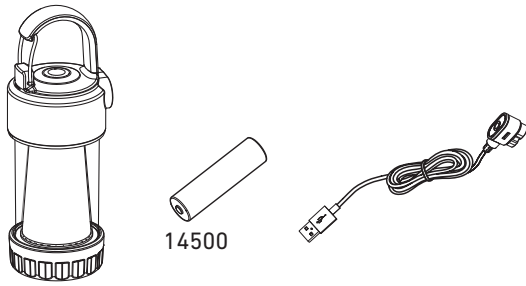
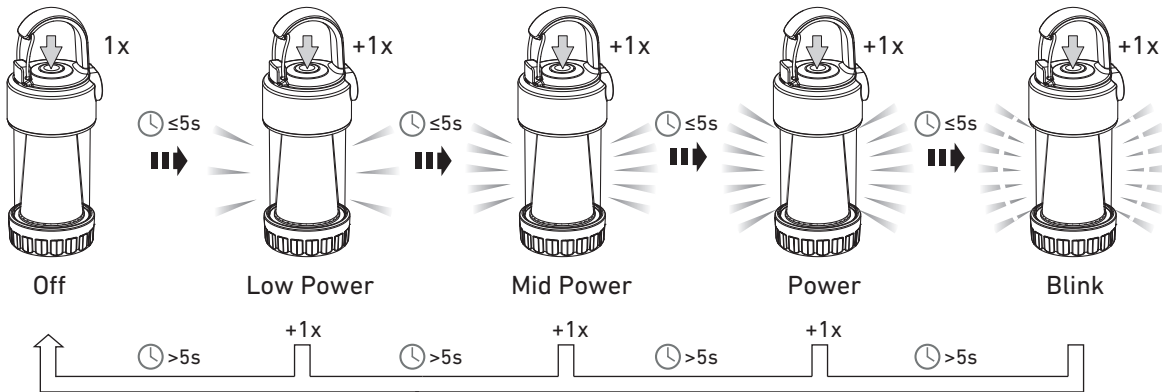

## Red Mode

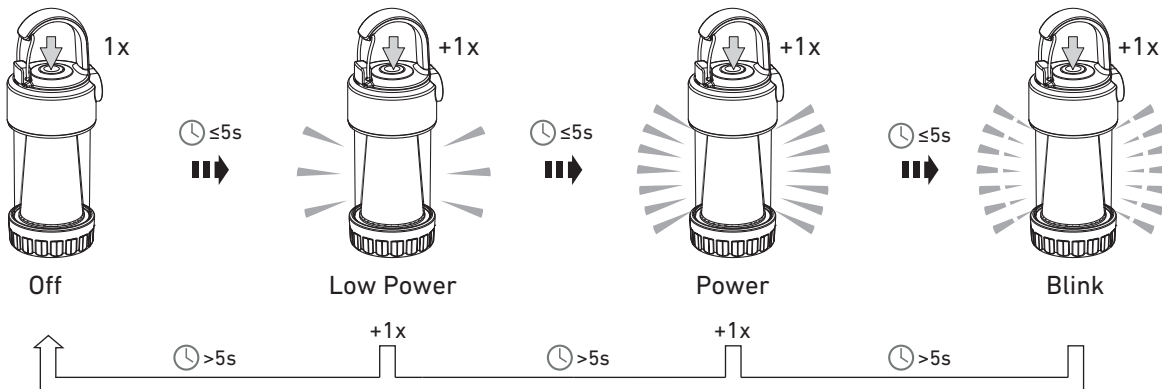

# LEDLENSER ML4

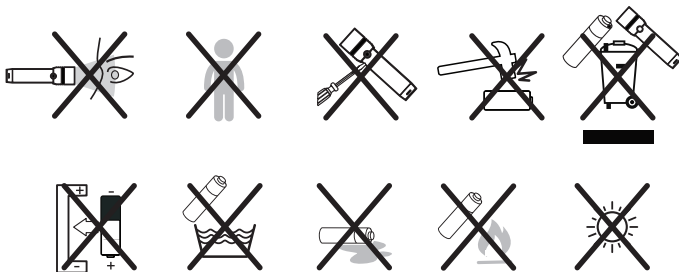
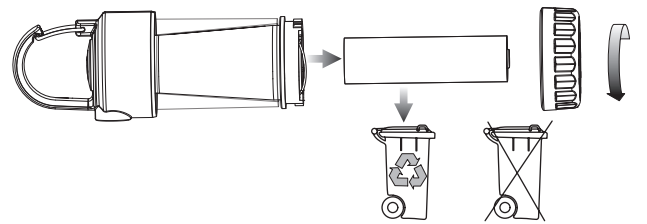
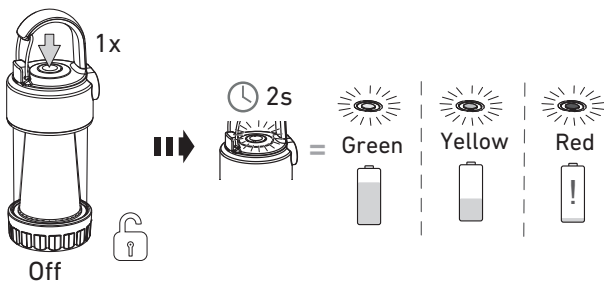
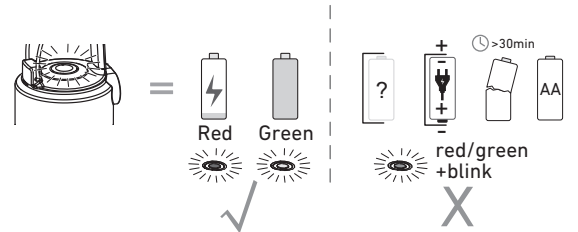
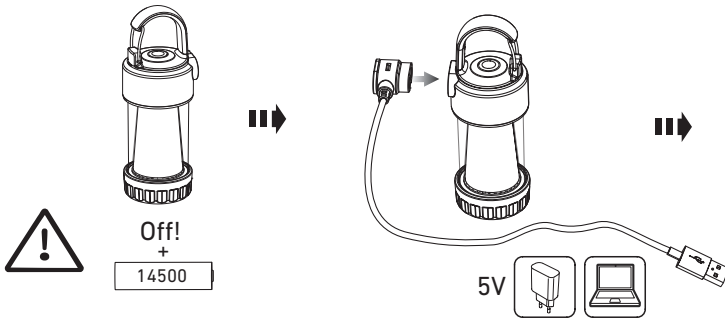
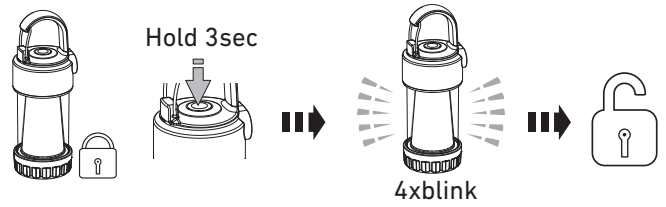
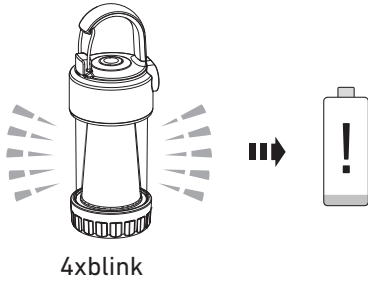
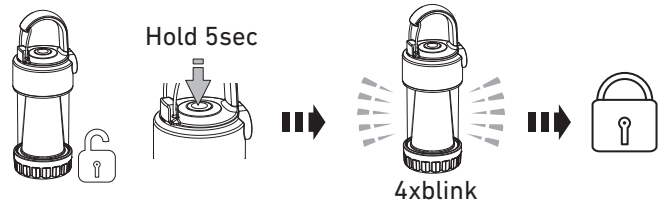
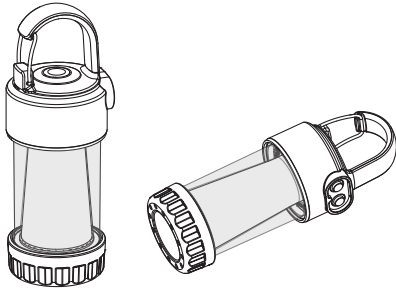

**Ledlenser GmbH & Co. KG**  
 Kronenstr. 5-7 • 42699 Solingen • Germany  
 Phone +49 212/5948-0 Fax +49 212/5948-200  
 info@ledlenser.com



ML4\_V.01  
 05.06.2019  
 1J12A0298